

**MORSETTI IN 2 META' AISI 316 DIN 2817 PER TUBI IN GOMMA**

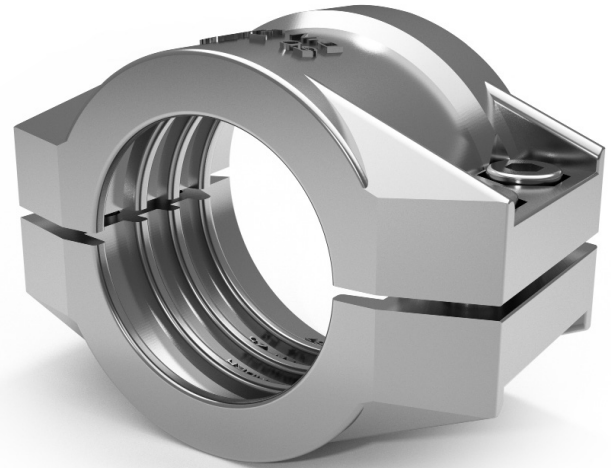

MATERIALE: AISI 316L

**Accessori di servizio per raccordi tipo portagomma:**

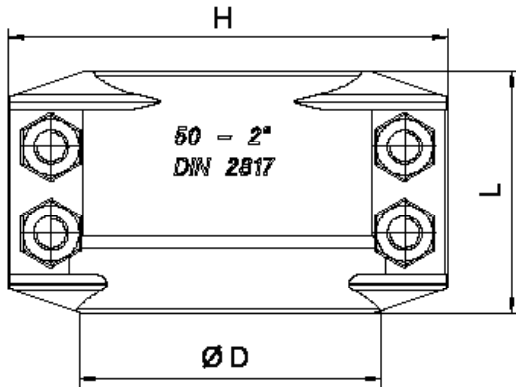
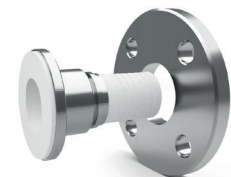
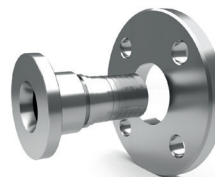
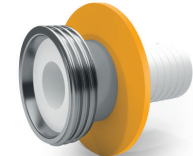
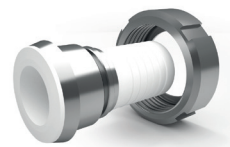
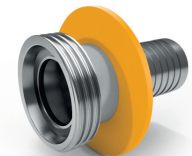

DN	Ø D	H	L	Bolts q.ty
15 - 1/2"	22-24	56	50	4xM6x20
20 - 3/4"	30-33	65	50	4xM6x20
25 - 1"	36-39	73	50	4xM6x20
32 - 1 1/4"	43-46	75	50	4xM6x20
40 - 1 1/2"	50-52	83	50	4xM6x20
50 - 2"	64-67	103	57	4xM8x25
65 - 2 1/2"	78-82	118	75	4xM8x25
80 - 3"	89-93	131	77	4xM8x25
100 - 4"	114-119	164	120	4xM10x40